

BLÜCHER® Channel

Linear drainage



BLÜCHER®

K E E P I N G U P T H E F L O W

STAINLESS STEEL DRAINAGE SYSTEMS



CONTENTS

BLÜCHER CHANNEL®

STANDARD CHANNEL RANGE

Standard channels with gratings

The right solution

Channel range overview

Channels Types 670 and 672

Channels Types 671 and 673

Kitchen Channels Type 660

Standard gratings overview

ACCESSORIES (to be ordered separately)

Lower parts and accessories overview

Lower parts and accessories

CUSTOMIZED SOLUTIONS

OPTIONS AND EXTRAS

Options

Optional Gratings

TECHNICAL INFORMATION

REFERENCES

4

6

6

10

11

12

14

16

18

19

19

20

23

24

25

26

27

31

Filter plate
501.000.000

Removable
502.05

Filter basket
780.107.110.05

670/672
= 147

OD 110mm

811.xxx.110

811.xxx.160

72.xxx

525.090.110

525.090.160



BLÜCHER CHANNEL®

BLÜCHER® stainless steel drainage system

On the basis of 40 years experience in the production and sale of stainless steel floor drainage solutions BLÜCHER has incorporated the very best features in the BLÜCHER Channel® range to provide an easy to use, high-performance off-the-shelf solution for drainage channels.

To our customers this means easy selection, fast delivery and competitive prices combined with optimum quality and corrosion resistance.

Stainless steel drainage systems

In addition to drainage channels, BLÜCHER also manufactures light- and heavy-duty floor drains and the BLÜCHER EuroPipe® push-fit drainage pipework system – all in stainless steel.

Founded in Denmark in 1965, BLÜCHER has developed into a leading manufacturer of stainless steel drainage systems. Today BLÜCHER is an international company with about 300 employees and with subsidiaries and representations worldwide.

The BLÜCHER® drainage products are manufactured in Denmark using the most modern production methods and in accordance with the internationally recognised quality standard ISO 9001.

All BLÜCHER® drainage products are made entirely in stainless steel AISI 304 or optionally AISI 316L. This material is ideally suitable for high-quality drainage systems:

- corrosion resistant
- fire resistant
- resistant to impacts and thermal stress
- high strength relative to its low weight
- smooth surface
- hardly any maintenance required
- environmentally friendly

In the BLÜCHER® drainage products these inherent qualities of stainless steel are enhanced by careful product design, thus resulting in:

- reliability
- ease of installation
- long product life expectancy
- excellent hygienic properties
- excellent flow properties
- installed cost advantages and whole-life cost advantages

All BLÜCHER® products are chemically descaled and passivated in order to enhance the natural corrosion resistance and provide a uniform matt-silver surface finish.

See also www.blucher.com

Standard channel range

The BLÜCHER® standard channel range comprises drainage channels for all common applications and for all common floor types, i.e. for concrete/in-situ/tiled floors or for vinyl floors.

The standard channels are available in lengths ranging from 1 m to 17 m and up to four standard widths, dependent on type of channel, and in variations with or without outlet box.

Each type of standard channel is available with different types of standard gratings suitable for weight loads from 1350 kg up to 8400 kg.

The BLÜCHER® standard channels are produced in stainless steel AISI 304/EN 1.4301.

Selecting a channel from the standard range is easy: Use the tables on pages 6 – 9 to identify type number for the channel requested, including grating. Then select lower part and accessories, using the diagrams on pages 13, 15 and 17.

Most standard channels can be supplied from stock with short lead times.

Options and extras

Stabiliser angles, adjustable legs, edge infill, other types of gratings, etc. are among the options available for the standard channel range. See pages 24-26.

Custom solutions

In addition to the BLÜCHER® standard channel range, BLÜCHER® also offers purpose-made channels on request to ensure that any drainage requirement can be satisfied. Our drainage know-how enables us to provide extensive engineering assistance – please contact our sales department. See also page 23.



STANDARD CHANNEL RANGE

Standard channels with gratings

The type nos. on page 7 specify standard channels including one of the three standard gratings.

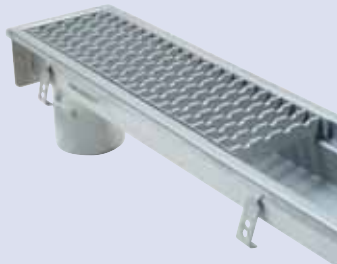
Description	Type	Width	Outlet	Length
 <p>For concrete, in-situ or tiled floors</p> <p>See page 12</p>	670	147 mm	OD 110 mm, end	L = 1000 mm
				L = 1500 mm
	L = 2000 mm			
	L = 3000 mm			
	197 mm	OD 160 mm, end	L = 1000 mm	
			L = 1500 mm	
L = 2000 mm				
L = 3000 mm				

 <p>For sheet vinyl floor covering</p> <p>See page 12</p>	672	147 mm	OD 110 mm, end	L = 1000 mm
				L = 1500 mm
	L = 2000 mm			
	L = 3000 mm			
	197 mm	OD 160 mm, end	L = 1000 mm	
			L = 1500 mm	
L = 2000 mm				
L = 3000 mm				

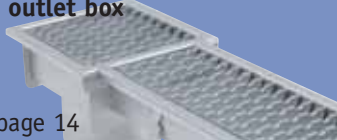
 <p>For concrete, in-situ or tiled floors with outlet box</p> <p>See page 14</p>	671	147 mm	OD 160 mm, end	L = 1000 mm
				L = 1500 mm
				L = 2000 mm
				L = 3000 mm

Lower parts are to be ordered separately, see overview p. 19 and description p. 20. For description of gratings see p. 18. Other channel and gratings, dimensions and types are available on request as customized solutions.

In addition to the standard solutions described above, BLÜCHER offers a range of options and customer-specific designed channels.

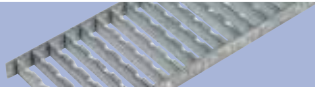
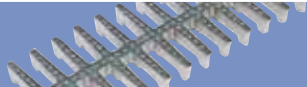
Type no. for channel incl. grating		
Mesh grating Pallet trucks, trolleys Max. load 1350/1800 kg	Ladder grating Delivery vans, lorries Max. load 5000 kg	HygienicPro Forklift trucks Max. load 6000/8400 kg
		
670.150.100.22	670.150.100.25	670.150.100.60
670.150.150.22	670.150.150.25	670.150.150.60
670.150.200.22	670.150.200.25	670.150.200.60
670.150.300.22	670.150.300.25	670.150.300.60
670.200.100.22	670.200.100.25	670.200.100.60
670.200.150.22	670.200.150.25	670.200.150.60
670.200.200.22	670.200.200.25	670.200.200.60
670.200.300.22	670.200.300.25	670.200.300.60
672.150.100.22	672.150.100.25	672.150.100.60
672.150.150.22	672.150.150.25	672.150.150.60
672.150.200.22	672.150.200.25	672.150.200.60
672.150.300.22	672.150.300.25	672.150.300.60
672.200.100.22	672.200.100.25	672.200.100.60
672.200.150.22	672.200.150.25	672.200.150.60
672.200.200.22	672.200.200.25	672.200.200.60
672.200.300.22	672.200.300.25	672.200.300.60
671.150.100.22	671.150.100.25	671.150.100.60
671.150.150.22	671.150.150.25	671.150.150.60
671.150.200.22	671.150.200.25	671.150.200.60
671.150.300.22	671.150.300.25	671.150.300.60

Standard channels with gratings

The type nos. on page 9 specify standard channels including one of the three standard gratings.

Description	Type	Width	Outlet	Length
For concrete, in-situ or tiled floors with outlet box 	673	60 mm	OD 160 mm, center	L = 3000 mm
				L = 4000 mm
				L = 5000 mm
				L = 6000 mm
				L = 7000 mm
				L = 8000 mm
				L = 9000 mm
				L = 10000 mm
				L = 11000 mm
				L = 12000 mm
				L = 13000 mm
				L = 14000 mm
				L = 15000 mm
L = 16000 mm				
L = 17000 mm				

See page 14

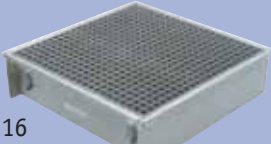
For concrete, in-situ or tiled floors 	660	400 mm	OD 160 mm, center	L = 400 mm
				L = 800 mm
				L = 500 mm
				L = 1000 mm

See page 16

Lower parts are to be ordered separately, see overview p. 19 and description p. 20. For description of gratings see p. 18. Other channel and gratings, dimensions and types are available on request as customized solutions.

In addition to the standard solutions described above, BLÜCHER offers a range of options and customer-specific designed channels.

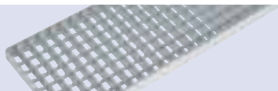
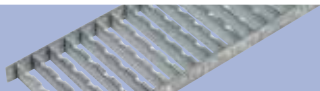
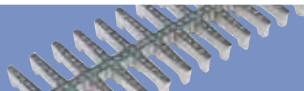
Type no. for channel incl. grating		
Mesh grating Pallet trucks, trolleys Max. load 1350/1800 kg	Ladder grating Delivery vans, lorries Max. load 5000 kg	HygienicPro Forklift trucks Max. load 6000/8400 kg
		
673.000.300.22	673.000.300.25	673.000.300.60
673.000.400.22	673.000.400.25	673.000.400.60
673.000.500.22	673.000.500.25	673.000.500.60
673.000.600.22	673.000.600.25	673.000.600.60
673.000.700.22	673.000.700.25	673.000.700.60
673.000.800.22	673.000.800.25	673.000.800.60
673.000.900.22	673.000.900.25	673.000.900.60
673.000.1000.22	673.000.1000.25	673.000.1000.60
673.000.1100.22	673.000.1100.25	673.000.1100.60
673.000.1200.22	673.000.1200.25	673.000.1200.60
673.000.1300.22	673.000.1300.25	673.000.1300.60
673.000.1400.22	673.000.1400.25	673.000.1400.60
673.000.1500.22	673.000.1500.25	673.000.1500.60
673.000.1600.22	673.000.1600.25	673.000.1600.60
673.000.1700.22	673.000.1700.25	673.000.1700.60

660FK004-11.22
660FK008-11.22
660GK005-15.22
660GK010-15.22

The right solution

Selecting a channel system:

- **Water load**

- continuous water flow
- intermittent discharge
- washdown

It is important to ensure that the lower part and trap arrangement has adequate flow capacity for the application.

- **Waste products**

Where possible a grate should be chosen which permits pieces of waste to pass through for collection in a filter basket.

- **Loading**

Can influence the choice of channel width as well as determining the most appropriate grating for the application.

- **Stainless steel grade**

AISI 304 (EN 1.4301)

- **Floor covering**

Concrete/tiles/in-situ (e.g. epoxy resin) or flexible sheet (e.g. vinyl).

- **Membrane type**

Where required liquid or dry membrane application will determine the choice of lower part.

See also technical information page 27.

Floor drainage methods

Choice of channel or industrial drain

To choose between a channel and a floor drain it is necessary to consider the room's use and design. For example the number and location of discharge points, frequency of discharge, the volume of water, the size of the room and the nature of the traffic in the room.

The following factors indicate that channels should be considered:

- Many discharge points. It is possible to install a channel network such that individual discharge points are picked up and water does not cover the entire floor and cause a safety hazard.
- Large floor area. Installing a channel in a large room allows the floor to be laid with less fall.
- Large quantities of surface water. The water content of a large channel acts as a buffer and reduces slip hazards.
- Breakwater. A channel in a door opening will isolate designated wet and dry areas.

Channel range overview

Type 670

Channel without outlet box for concrete, in-situ and tiled floors

Width:	147 and 197 mm grate location width
Outlet:	OD 110 or OD 160 mm plain spigot
Length:	1-3 metres
Max depth at outlet:	90 mm
Typical applications:	Shower areas, kitchens, food & beverage production, chemical plants, abattoirs



Type 672

Channel without outlet box for sheet vinyl floor covering

Width:	147 and 197 mm grate location width
Outlet:	OD 110 or OD 160 mm plain spigot
Length:	1-3 metres
Max depth at outlet:	90 mm
Typical applications:	Shower areas, kitchens, laboratories



Type 671*

Channel with outlet box for concrete, in-situ or tiled floors

Width:	147 mm grate location width
Outlet:	Outlet box with OD 160 mm outlet
Length:	1-3 metres
Max depth at outlet:	90 mm
Typical applications:	Kitchens, food & beverage production, chemical plants, abattoirs



Type 673

Slot channel with outlet box for concrete, in-situ or tiled floors

Width:	20 mm aperture (B)
Outlet:	Outlet box with OD 160 mm outlet
Length:	3-17 metres
Max depth at outlet:	78, 93 or 108 mm
Grating:	For outlet box only
Typical applications:	Shower areas, beverage production, chemical plants, swimming pools, breakwaters



Type 660

Kitchen channels are for concrete/tiled floors

Kitchen channels for flexible sheet flooring or for floors with membrane are also available on request.

Dimensions:	400 x 400, 400 x 800, 500 x 500 or 500 x 1000 mm
Outlet:	OD 160 mm outlet
Depth at outlet:	150 mm
Typical applications:	Commercial kitchens, restaurants, etc.

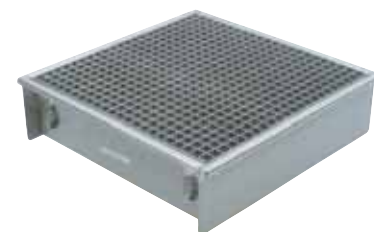

* The advantage of type 671 relative to type 670 is that with a narrow channel 147 mm grate location width it is possible to achieve a higher outlet capacity via the OD 160 mm outlet box.

All channels with OD 160 mm outlet box can be combined with horizontal or vertical lower parts, with or without a membrane flange. This detail also provides 60 mm height adjustment and full rodding access via the removable water trap.

Type 670

Channel without outlet box for concrete, in-situ or tiled floor

The channel is made in the following standard widths: 147 and 197 mm.

A range of gratings is available to suit the varying load and flow requirements.

Application areas:

- For discharge directly into the channel
- For waste water with solids present
- Where the channel's water content is required as a buffer
- Shower areas, kitchens, food & beverage production, chemical plants, abattoirs

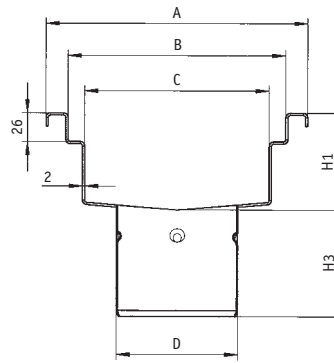

Channel type	Outlet	A	B	C	D	H1	H3
670.150.xxx.xx	End	187	147	117	110	90/120	98
670.200.xxx.xx	End	237	197	167	160	90/120	83

Type 672

Channel without outlet box for sheet vinyl floor covering

The channel is made in the following standard widths: 147 and 197 mm.

A range of gratings is available to suit the varying load and flow requirements.

Application areas:

- Where the channel's water content is required as a buffer
- For discharge directly into the channel
- For waste water with solids present
- Vinyl thickness from 2 - 4 mm
- Shower areas, kitchens, laboratories, doorways

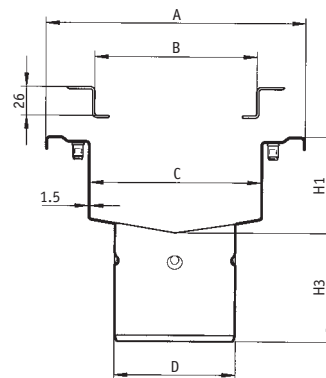
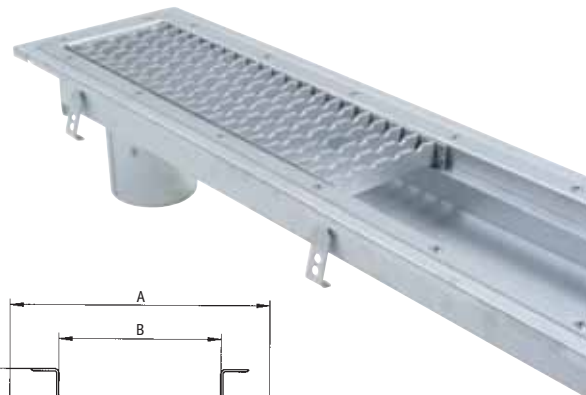

Channel type	Outlet	A	B	C	D	H1	H3
672.150.xxx.xx	End	235	147	155	110	90/120	98
672.200.xxx.xx	End	285	197	205	160	90/120	83

Accessories

The diagram below shows accessories and outlet configurations achievable

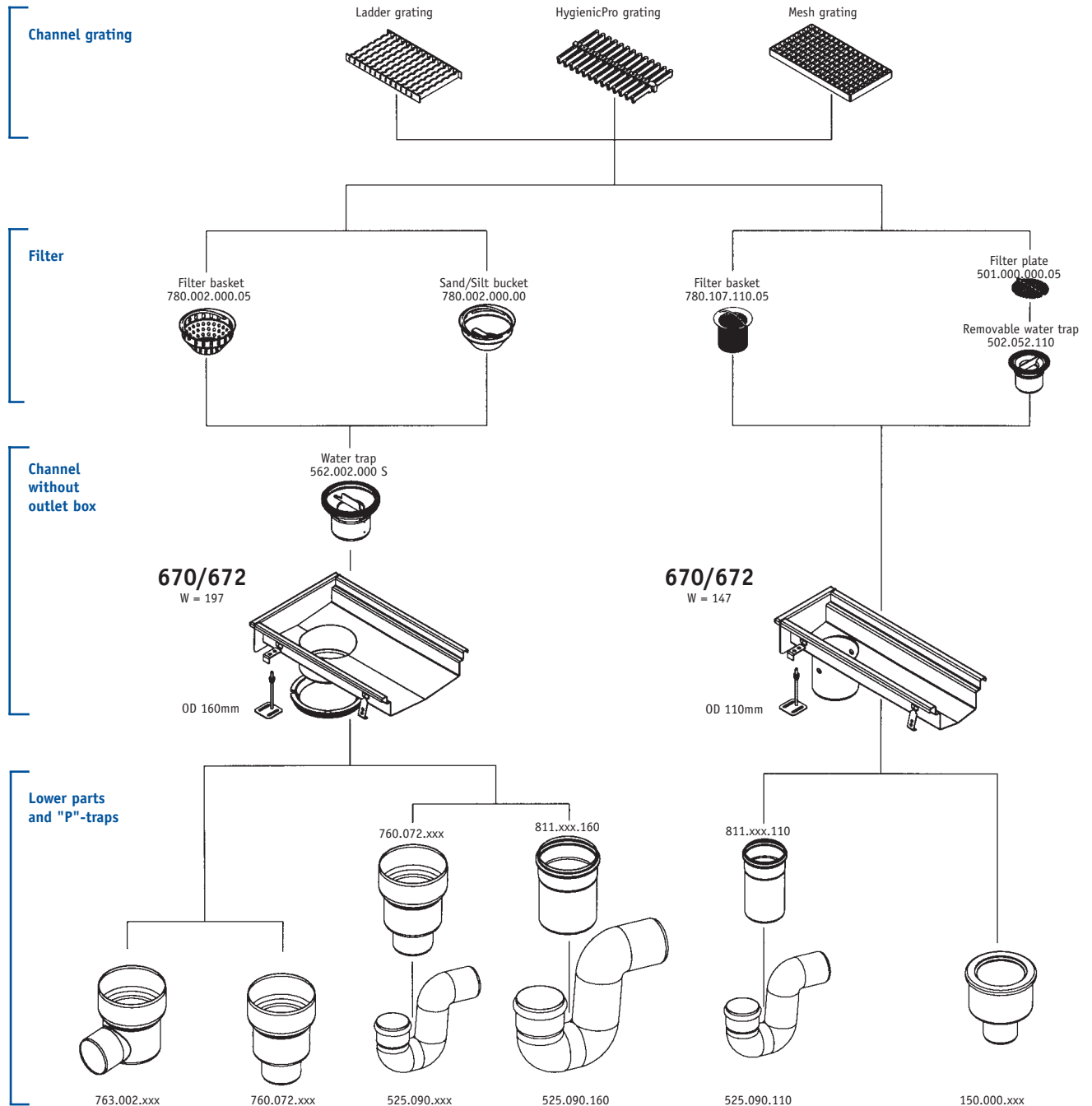

Type 671

Channel with outlet box for concrete, in-situ or tiled floor

The channel is made in a standard width of 147 mm internal frame dimension. The benefit of the outlet box is that at 147 mm channel width it is possible to combine the channel with lower parts, removable water trap, 'P' trap, filter basket and sand/silt bucket.

A range of gratings is available to suit the varying load and flow requirements.

Application areas:

- For discharge directly into the channel
- For waste water with solids present
- Where the channel's water content is required as a buffer
- Kitchens, food & beverage production, chemical plants, abattoirs

Outlet box

The outlet box is supplied in one standard size and outlet dimension.

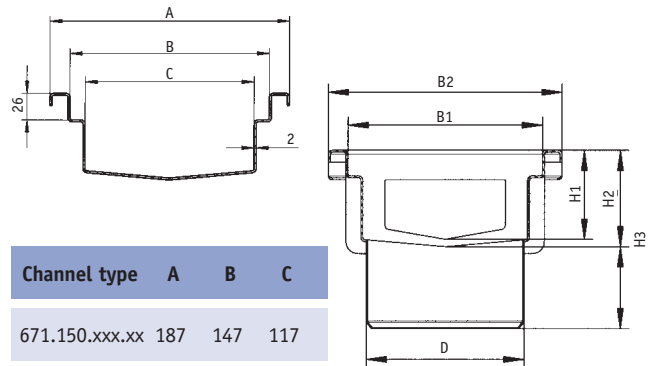

Channel type	A	B	C
671.150.xxx.xx	187	147	117

Outlet box	D	B1	B2	H1	H2	H3
End	160	197	237	90	100	83

Type 673

Slot channel with outlet box for concrete, in-situ or tiled floors

Slot channel requires no grating but instead has a 20 mm aperture along the channel length, making it the most cost effective solution in the modular range.

The profile shape has been developed to make it robust, hygienic and most suitable for applications where wastewater discharges carry little or no solid matter. A range of gratings is available for the outlet box.

Application areas:

- As a breakwater to separate designated wet and dry areas
- Washdown areas where wastewater contains low solid content
- Low floor constructions – the reduced channel invert means that Slot channel can be installed within restricted floor spaces
- Shower areas, beverage production, chemical plants, swimming pools, breakwaters

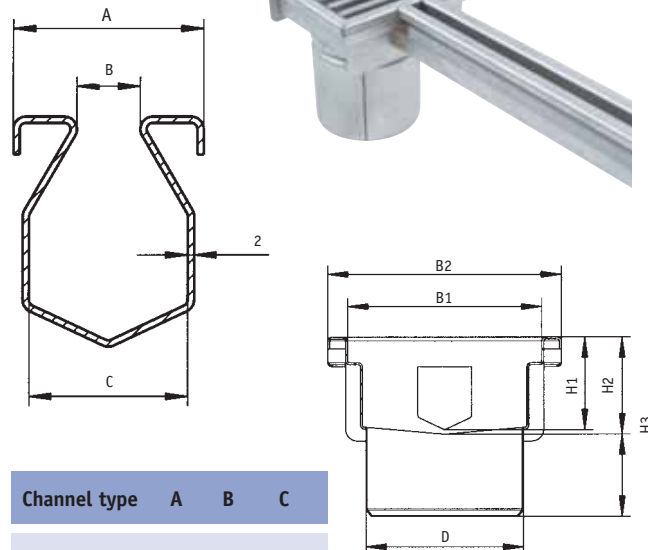

Channel type	A	B	C
673.000.xxx.xx	60	20	50

Outlet box	L	D	B1	B2	H1	H2	H3
Center	3-6 m	160	197	237	78	85	83
	7-11 m	160	197	237	93	100	83
	12-17 m	160	197	237	108	120	83

Accessories

The diagram below shows accessories and outlet configurations achievable

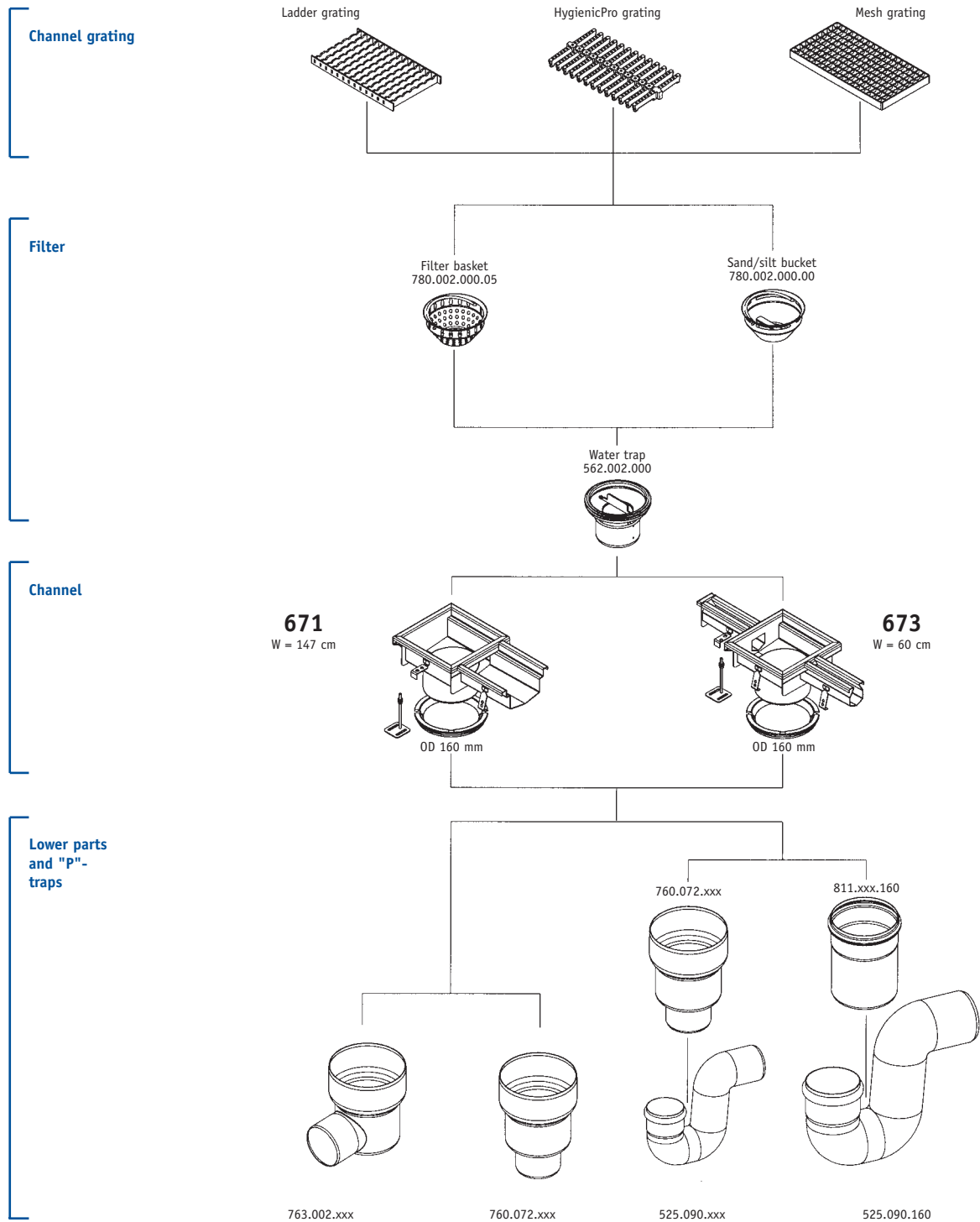

Type 660

Kitchen channel for concrete floors

The kitchen channel is made in standard sizes 400x400, 400x800, 500x500 and 500x1000 mm. For the kitchen channel, a mesh grating is available.



Application areas:

- For discharge directly into the channel
- For waste water with solids present
- Commercial kitchens

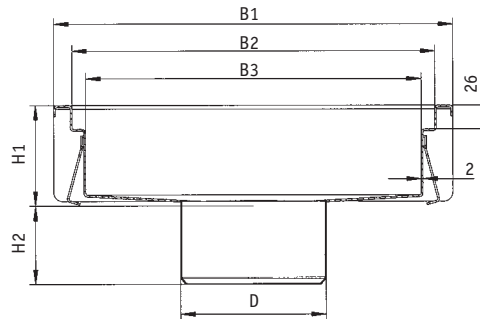

Channel type	Designation	B1	B2	B3	H1	H2	D
660FK004-11.22	400 x 400	437 x 437	397 x 397	367	110	85	160
660FK008-11.22	400 x 800	437 x 837	397 x 797	367	110	85	160
660GK005-15.22	500 x 500	537 x 537	497 x 497	467	150	85	160
660GK010-15.22	500 x 1000	537 x 1037	497 x 997	467	150	85	160



Accessories

The diagram below shows accessories and outlet configurations achievable

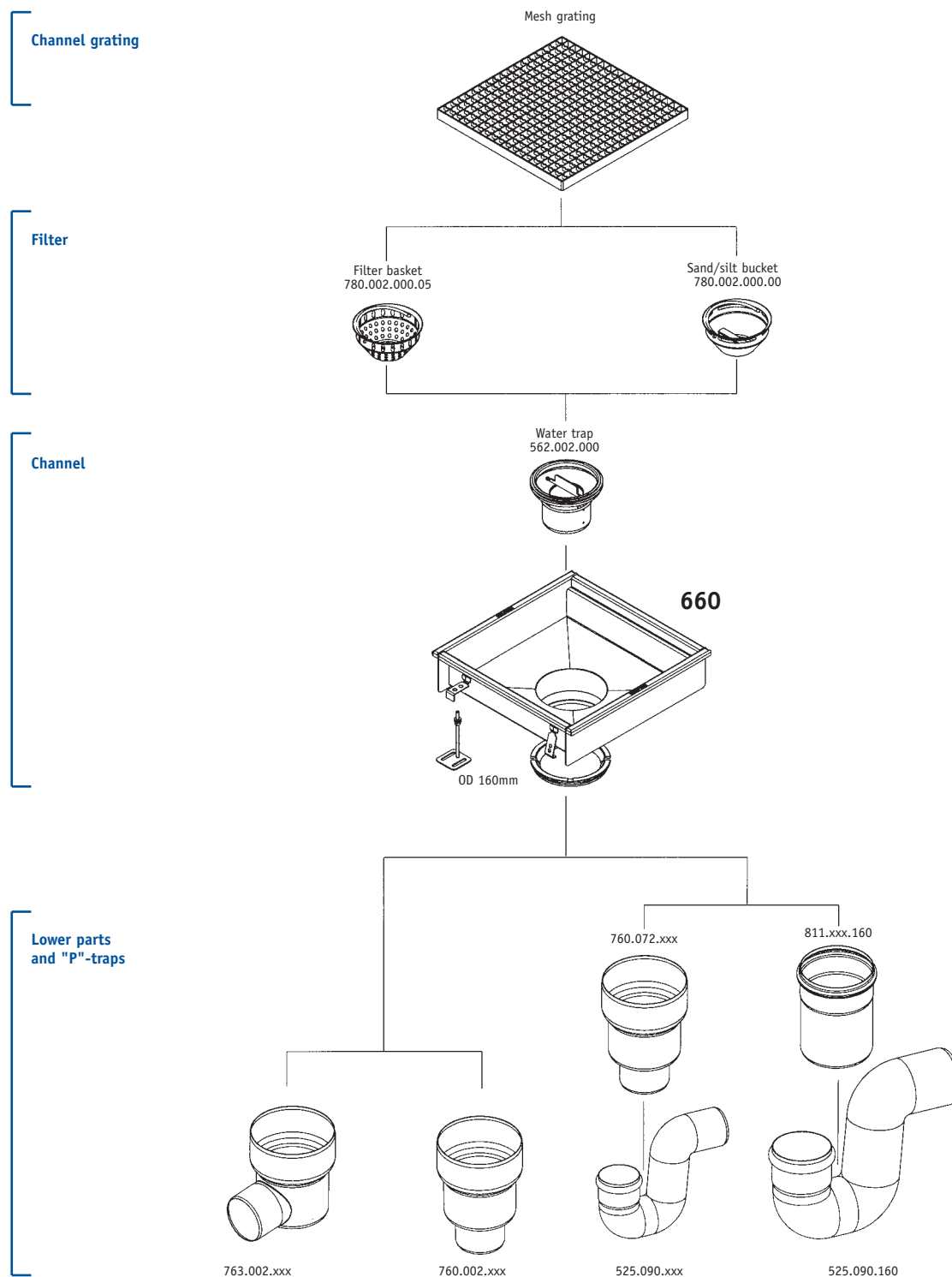

Standard gratings overview

Gratings for channels and outlet boxes.
All gratings are 25 mm deep at the bearing point to ensure a precise fit in the channel profile.

Mesh grating

25 x 2 mm and 10 x 2 mm flat steel with non-skid surface. Aperture size 22 x 22 mm.

Width: 144 mm and 194 mm
For kitchen channels: 394 mm and 494 mm

Length: 998 mm
For kitchen channels: 394 mm and 494 mm

DIN (loading class): 1350/1800 kg

Stainless steel grade: AISI 304/EN 1.4301

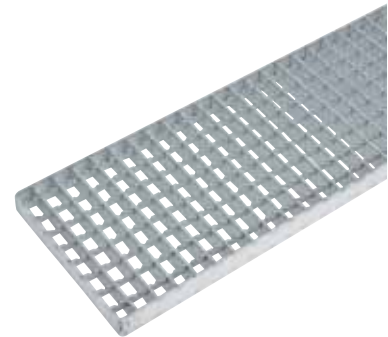

Ladder grating 25/5

25 x 5 mm spot welded flat steel with 19 mm distance between bars. Grating reversible with non-skid surface to one side.

Width: 145 mm and 195 mm

Length: 499 mm

DIN (loading class): 5000 kg

Stainless steel grade: AISI 304/EN 1.4301



HygienicPro grating

Fully cast stainless steel with non-skid surface.

Width: 145 mm and 195 mm

Length: 499 mm

DIN (loading class): 6000/8400 kg

Stainless steel grade: AISI CF-8/EN 1.4308

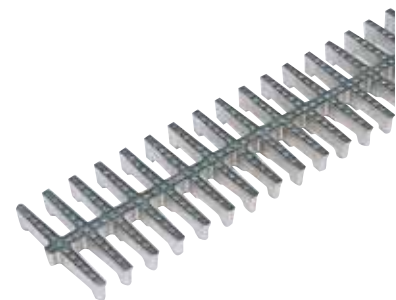

Other gratings, dimensions and types are available on request as customized solutions.

ACCESSORIES (to be ordered separately)

Lower parts and accessories overview

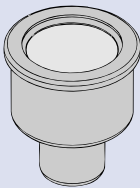
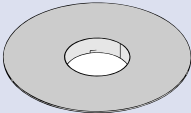
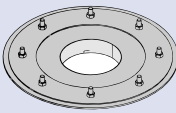
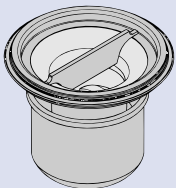
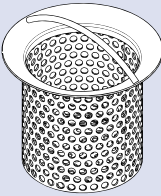
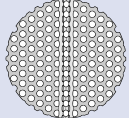
Channel outlet size	Lower part	Flange		Water trap	Filter basket/ filter plate
		Liquid membrane	Sheet membrane		
OD 110 mm outlet	 150.000.075 150.000.110	 362.302.000	 325.302.000	 502.052.110	 780.107.110.05 S
		 501.000.000.05 S			

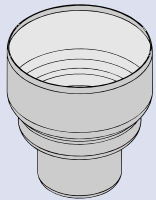
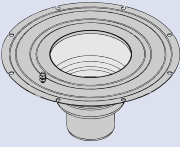
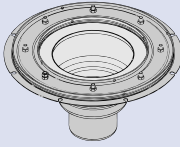
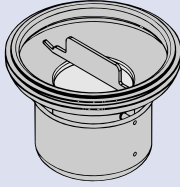
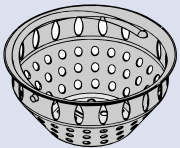
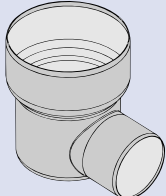
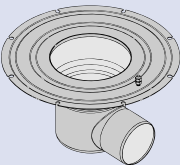
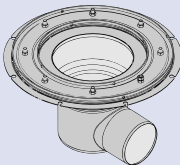
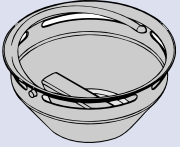
Channel outlet size	Lower part			Water trap	Filter basket/ sand bucket
	No membrane	Liquid membrane	Sheet membrane		
OD 160 mm outlet	 760.072.110	 774.072.110	 775.072.110	 562.002.000 S	 780.002.000.05
	 763.002.110	 769.002.110	 771.002.110		 780.002.000.00

Adjustable legs



670.000.001

Lower parts, water traps and accessories to be ordered separately.

Lower parts and accessories

The outlet of all BLÜCHER channels can be combined with either horizontal or vertical outlet lower parts. The outlet size determines the size and types available of removable water trap and/or filter basket or sand bucket. See also diagrams pages 13, 15 and 17. In addition the lower part provides height adjustment making it easier to set the channel to the required finished floor level.

Where connection to a damp proof membrane is required there are also lower parts which are suitable for use with either liquid or dry membranes.

The capacity of the lower parts is dependent on the type of water trap, filter basket etc. selected. Please see the capacities stated for these.



Lower parts without membrane flange

Type number	D1	D2	D3	H1	H2
150.000.075	75	113	140	74	170
150.000.110	110	113	140	74	148

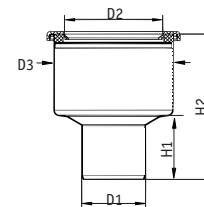

Flange for liquid membrane

for lower parts types 110 and 150

Type number	D1	D2	H
326.302.000	113	320	30

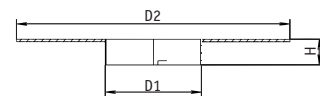

Flange for sheet membrane

for lower parts types 110 and 150

Type number	D1	D2	D3	H
325.302.000	113	250	320	30

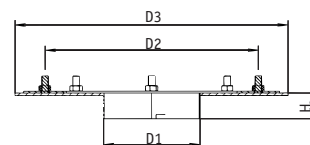

All dimensions in mm

Lower parts without membrane flange

Type number	Outlet	D1	D2	H1	H2
760.072.075	OD 75 mm	75	190	65	261
760.072.110	OD 110 mm	110	190	75	271

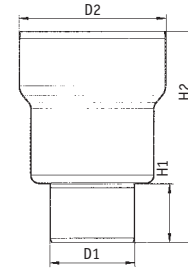

Lower parts without membrane flange

Type number	Outlet	D1	D2	H1	H2	B	L
763.002.075*	OD 75 mm	75	190	180	217	253	60
763.002.110	OD 110 mm	110	190	165	217	155	70

* With adaptor from OD 110 mm to OD 75 mm

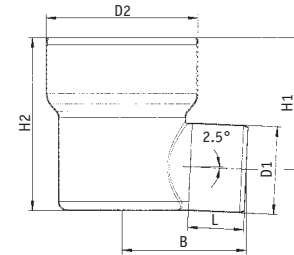

Lower parts with flange for liquid membrane

Type number	Outlet	D1	D2	D3	H1	H2
774.072.075	OD 75 mm	75	190	409	65	261
774.072.110	OD 110 mm	110	190	409	76	271

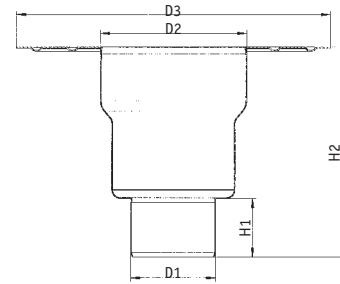

Lower parts with flange for liquid membrane

Type number	Outlet	D1	D2	D3	H1	H2	B	L
769.002.075*	OD 75 mm	75	190	409	180	217	253	60
769.002.110	OD 110 mm	110	190	409	165	217	155	70

* With adaptor from OD 110 mm to OD 75 mm

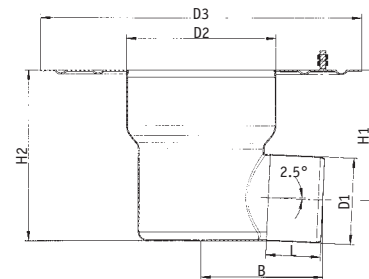

Lower parts with flange for dry membrane

Type number	Outlet	D1	D2	D3	H1	H2
775.072.075	OD 75 mm	75	190	409	65	261
775.072.110	OD 110 mm	110	190	409	76	271

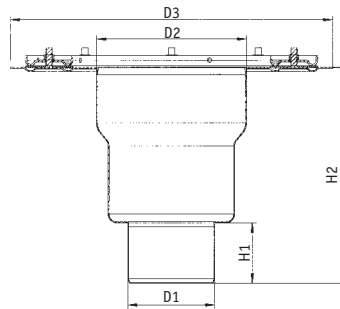

Lower parts with flange for sheet membrane

Type number	Outlet	D1	D2	D3	H1	H2	B	L
771.002.075*	OD 75 mm	75	190	409	180	217	253	60
771.002.110	OD 110 mm	110	190	409	165	217	155	70

* With adaptor from OD 110 mm to OD 75 mm

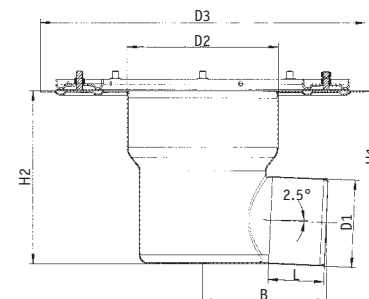

All dimensions in mm

Removable water traps for lower parts

Type number	Capacity*	VL	Suitable for
502.052.110	0.7 l/sec	52	OD 110 mm outlet
562.002.000 S	3.3 l/sec	52	OD 160 mm outlet

* Capacity when used together with lower part with vertical outlet.
For capacities when used together with other types of lower part, please contact BLÜCHER.

P-Trap

Stainless steel grade AISI 316L

Type number	D	Capacity	X1	X2	X3	VL
525.090.075 S	75	1.8 l/sec	93	222	189	81
525.090.110 S	110	5.0 l/sec	132	289	249	89
525.090.160 S	160	13.5 l/sec	184	388	338	105

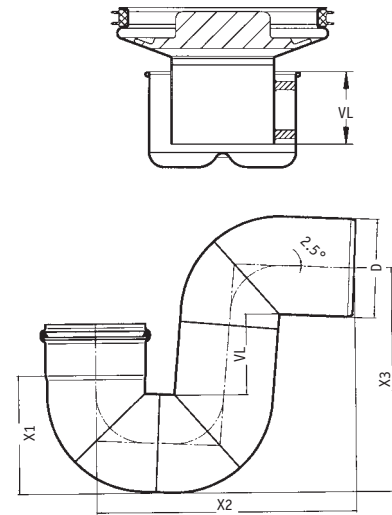

Extension pipes – socketed one end

Type number	D	L
811.015.075	75	150
811.025.075	75	250
811.050.075	75	500
811.015.110	110	150
811.025.110	110	250
811.050.110	110	500
811.015.160	160	150
811.025.160	160	250
811.050.160	160	500

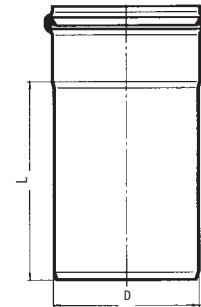

Filter basket

Type	D1	D2	H	Vol.
780.002.000.05	140	155	74	0,9 l

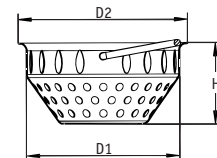

Filter basket

Stainless steel grade AISI 316L

Type	D1	D2	H	Vol.
780.107.110.05 S	80	107	88	0,44 l

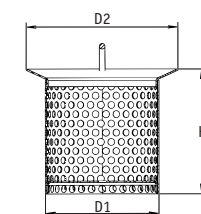

Filter cover for removable water trap

Stainless steel grade AISI 316L

Type	Suitable for water trap type	D
501.000.000.05 S	502.052.110	90

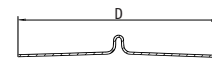

Sand bucket

Type	D1	D2	H	Vol.
780.002.000.00	140	155	74	0,6 l

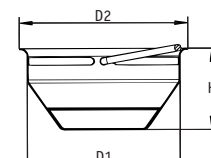

Adjustable legs

Type	Height (rod)	OD (rod)
670.000.001	150	M8 threaded



CUSTOMIZED SOLUTIONS BLÜCHER

BLÜCHER also offers purpose-made channels on request to ensure that any drainage requirement can be satisfied, e.g.:

- Channels with corners
- Channels with T-pieces
- Channels in customized lengths
- Channels and gratings in customized widths
- Channels in customized designs
- Channels for other types of flooring
- Channels in acid-resistant stainless steel grade 316L
- Other types of gratings

Due to our experience in working with customized products, we are able to deliver purpose-made channels with short lead times.

Our drainage knowhow enables us to provide extensive engineering assistance. Please contact our sales department.



OPTIONS AND EXTRAS

A range of options and extras as follows is available for the standard channel system. For more information or ordering of options, please contact BLÜCHER.

In addition to the standard channel programme, BLÜCHER offers customized channels. Founded on 40 years experience, we offer our extensive knowhow to deliver quality solutions to any drainage requirements.



Options

The connection between concrete and channel is particularly important for channels exposed to heavy loadings and temperature differences. Two standard options are available to protect the channel from the effect of these factors.

Stabiliser angle

The stabiliser angle is longitudinally welded to the channel wall supporting the channel and in contact with the concrete throughout the channel's length. The stabiliser angle is therefore recommended for use where the channel is subjected to heavy wheel loadings.

Adjustable legs can be added to the stabiliser angle for use in adjusting the channel to the required finished level before casting.

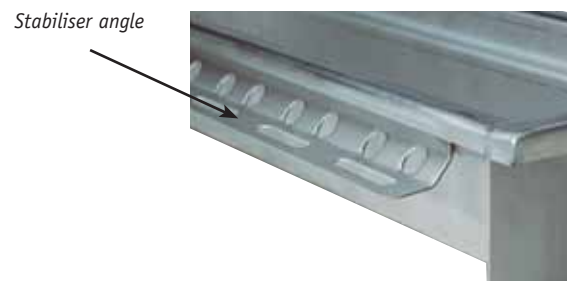

Edge infill

Edge infill – For optimum channel strength it is important that the channel is properly embedded in concrete. This is particularly necessary with regard to the underside of the channel edge profile. Whilst this can be filled on site it is also possible to have the filling carried out under factory conditions as part of the production process.

In addition to providing greater rigidity to the channel, the edge infill also prevents bacterial growth.

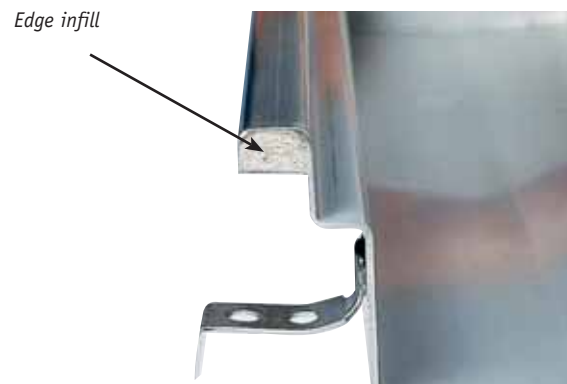

Protective strip

The edge profile can be supplied with a protective strip which adheres lightly and is easily removed. This is to protect the edge profile during installation leaving a perfect visible edge once the installation is complete.

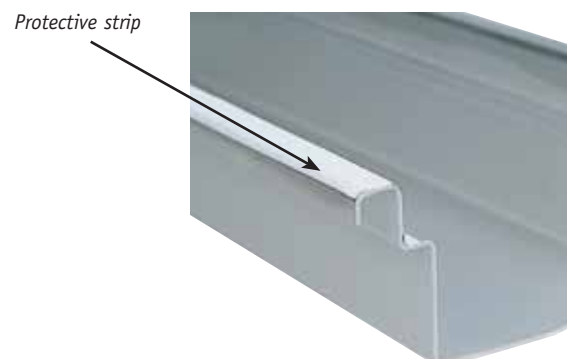

Optional gratings

A range of optional gratings for various loads are also available on request.

Shower grating

2 mm material thickness with holes 8 x 8 mm

Width: 145 mm

Length: 998 mm

DIN (loading class): 300 kg

Stainless steel grade: AISI 304 (EN 1.4301)



Non-skid grating

2 mm material bent into profiles with non-skid pattern

Width: 144 and 194 mm

Length: 998 mm

DIN (loading class): 1000 - 1200 kg

Stainless steel grade: AISI 304 (EN 1.4301)



Annular grating

10 mm thick plate with welded support bars and 8 mm aperture

Width: 145 and 195 mm

Length: 998 mm

DIN (loading class): 3500 - 7000 kg

Stainless steel grade: AISI 304 (EN 1.4301)



Ladder grating 50/5

50 x 5 mm spot welded flat steel with distance between bars of 19 mm. Grating non-skid.

Width: 145 mm and 195 mm

Length: 499 mm

DIN (loading class): 8400 kg

Stainless steel grade: AISI 304 (EN 1.4301)



All dimensions in mm

TECHNICAL INFORMATION

Installation heights

Dimensioned sketch for channels with OD 110 mm outlet

The drawings below show the position of the outlet relative to the finished floor. The dimension H1 corresponds to the channel's depth (90 or 120 mm) at the outlet. Please note that the channel can be adjusted 50 mm relative to the lower part.

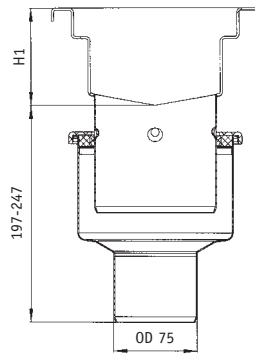

150.000.075

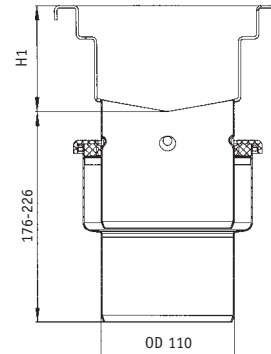

150.000.110

Dimensioned sketch for channels with OD 160 mm outlet

The drawings below show the position of the outlet relative to the finished floor. The dimension H1 corresponds to the height of the outlet box = 85 (type 673 only), 100 or 120 mm (depending on the channel depth selected). Note that the outlet box/channel can be adjusted 50 mm relative to the lower part.

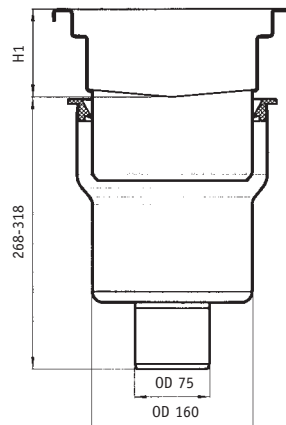

760.072.075

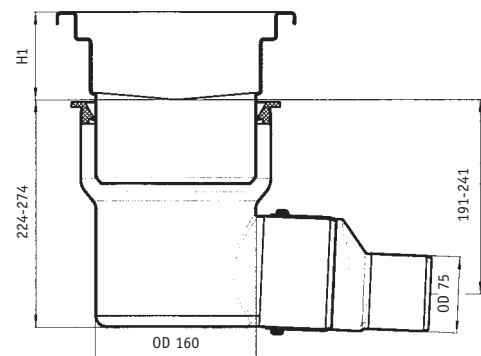

763.002.075

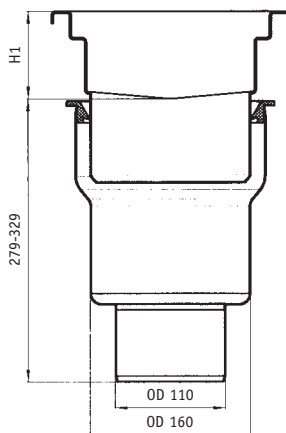

760.072.110

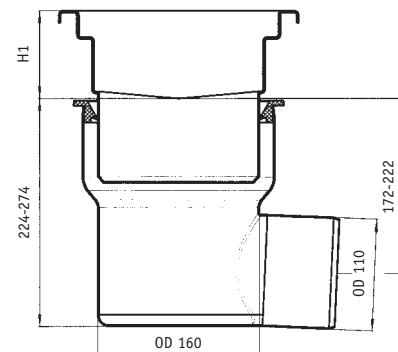

763.002.110

Material quality

- Unless otherwise stated, the standard channel range is made in AISI 304 (material no. 1.4301). On request, the channels and most of the gratings and accessories can be supplied in AISI 316L as an option.
- All channels are chemically pickled and passivated to provide a clean hygienic surface finish.

Material thickness

- Channels for concrete, in-situ or tiled floors: 2 mm, ensuring the channel can be used where there are heavy loads.
- Channels for sheet vinyl floor covering: 1.5 mm – vinyl covered floors are not exposed to heavy loads.

Material thickness

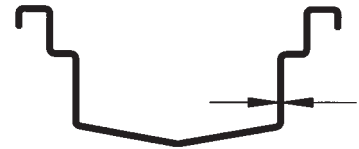

Anchor tang

Anchor tangs are positioned every 500 mm along the channel wall and should be bent out 90° before casting. Anchor tangs are generally suitable where the channel is not subjected to excessive weight or thermal loadings (e.g. medium/light industrial). Adjustable legs can be added to the anchor tangs.

Anchor tang



Grating support

- 26 mm shoulder depth ensures that 25 mm gratings do not protrude above the channel.
- 15 mm shoulder width ensures that there is adequate support for the various grating types. Keeping this shoulder to a minimum is important for hygiene reasons to prevent bacteria growth on the horizontal surface.

Cross bars

- 8 x 20 mm flat bar placed to give 1000 mm grate location gaps in channels.
- OD 8 mm round bar steel is placed at 500 mm centres in slot channels.

Cross-bars reinforce the channel and ensure that it is not pressed together during embedding in concrete. Cross-bars also ensure that the grates are not displaced longitudinally.

Cross-bars



Longitudinal fall

- In Slot channels the longitudinal fall is 0.5-0.6%; for all other channel types the fall is 1%.

Cross fall

- Together with the longitudinal fall, cross fall ensures that the waste water and solids flow to the outlet without leaving deposits. The cross fall corresponds to an angle of 130° in Slot channels and 150-170° for all other channel types.

Flanged joint

- Channels with a total length exceeding 6 metres are made in two or three sections which can be bolted together with flanged joints. The flanges are 5 mm thick and finish flush with all internal surfaces. One of the two mating flanges is supplied with a 2 mm thick EPDM seal.
 - The flanges are tightened (30 Nm) together with the OD 8 mm nuts and bolts supplied.
 - After jointing, it may be necessary to cut away any excess seal inside the channel. This can be done with a sharp thin bladed knife. Approx. 2 mm of the seal will remain visible after making a flanged joint. Each flange protrudes 34 mm from the channel bottom.

Outlet

- Channels are provided with either a plain spigot outlet or an outlet box. The outlet fits either directly into the interconnecting pipework or into an adjustable lower part.

The outlet size determines the size and types available of removable water trap and/or filter basket or sand bucket. See also diagrams pages 13, 15 and 17.

Longitudinal fall

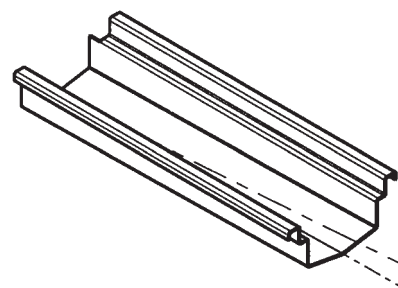

Cross fall

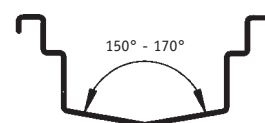

Flanged joint

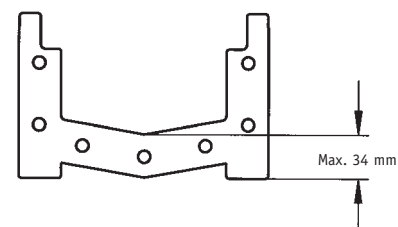

Outlet box



Plain spigot



Calculation of channel length

Where there are no special circumstances to be taken into account, the diagrams below can be used as a guide for establishing the correct location and design of channels so that a constant fall is achieved to the drainage channel

As most floors with channels are laid to falls, account must be taken at the planning stage to ensure the fall (A) does not exceed 1-2% (depending on floor type).

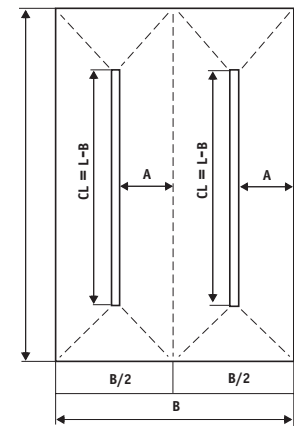
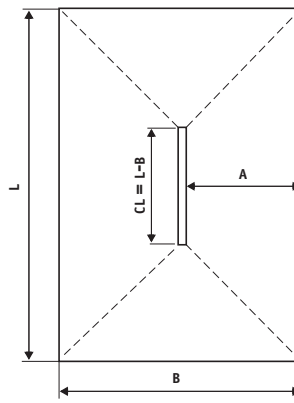
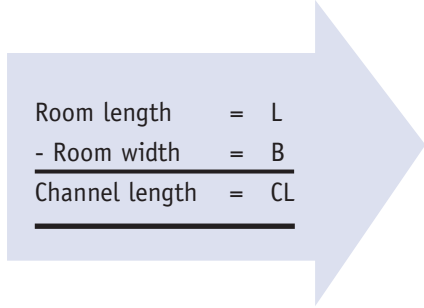

REFERENCES

BLÜCHER® channels have proven their functionality and reliability in all kinds of application areas throughout the past four decades. Among the numerous users of BLÜCHER® channels are:

- Almarai Dairy (Saudi Arabia)**
- Arla Foods**
- Coca-Cola Company**
- Danish Crown slaughterhouses (Denmark)**
- Danone**
- Danpo Poultries**
- Heineken Breweries**
- Hilton Hotels**
- IKEA**
- Lundbeck Pharmaceuticals**
- Novo Nordisk**
- Vena Brewery (Sct. Petersburg)**



Sand/silt bucket
780.002.000.00 S

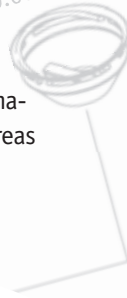

673
W = 60 cm

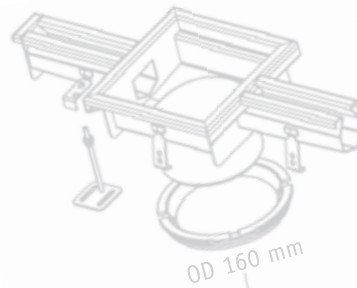

760.072.xxx



811.xxx.160



525.090.160

525.090.110

760.072.xxx

BLÜCHER®

BLÜCHER employs over 300 staff who, through commitment and know how have developed a range of high quality stainless steel drainage systems which are sold throughout the world.

For more information on you local supplier log on to www.blucher.com

BLÜCHER® EuroPipe

BLÜCHER® Channel

BLÜCHER® Drain



KEEPING UP THE FLOW